

# PRODUCT NEWS

PN-E-018



## Swing Ball NEO

Indexable Ball Nose End Mill  
SWBX/MSWX

For Roughing



Shank type / Modular type:  $\varnothing 16 \sim \varnothing 30$

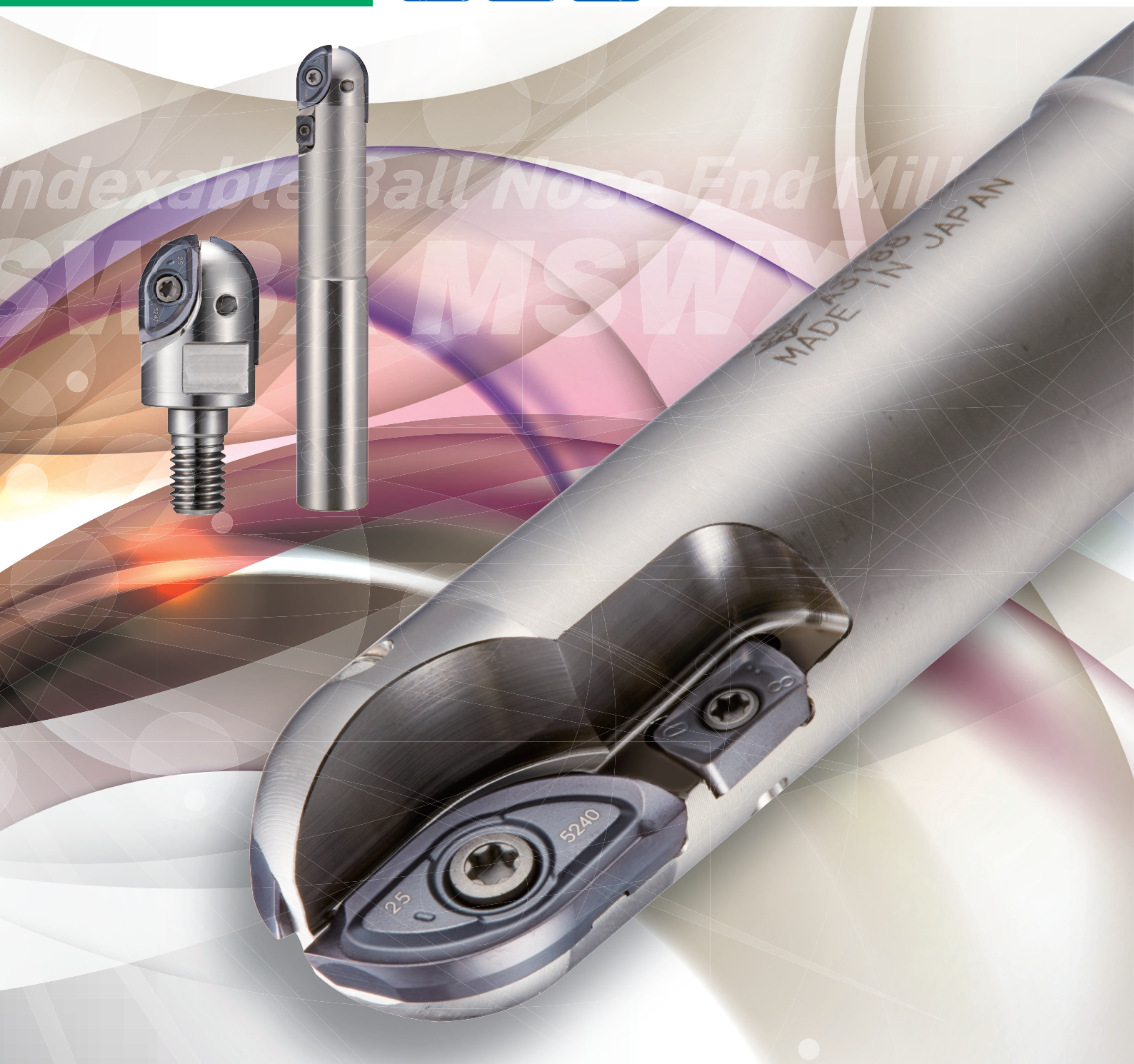

## Features

1. Unique key on the body and insert fixes the inserts strongly and enables stable roughing process & machining welding parts for die in 3D machining.
2. Applicable to not only roughing process but also semi-finishing process due to high repeatability on mounting insert.
3. Adopted new PVD coated grades "JC5240" for steel and "JC8118" & "JC8015" for cast iron, mold steel, welding & hardened die steel.



### ■ Insert grade

For steel



JC5240

For cast iron,  
mold steel  
& welding  
& hardend  
die steel.



JC8118, JC8015

Insert with breaker for low cutting force (-HM/-HS type) adopted 2 insert grades: new PVD coated grade "JC5240" for steel improved both fracture toughness and wear resistance. "JC8118" can be widely applied such as general & mold steel and cast iron.

Strong edge type Insert (-MMW/-MSW type) adopted "JC8118" & "JC8015" is possible to machine welding & hardened die steel (50-60HRC).

### ■ Radius form accuracy for rotation

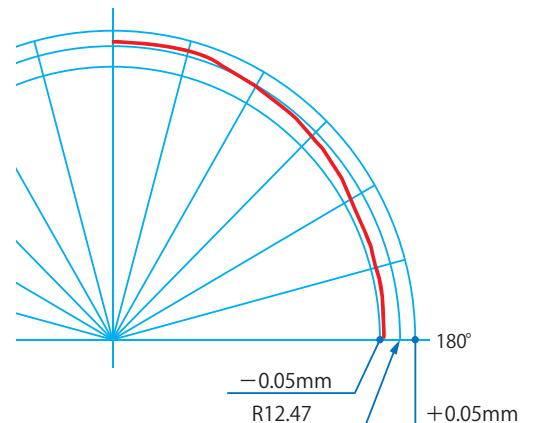

Insert No. :  
SWBX225HM/HS ( $\phi 25$  (R12.5))  
Actual : R12.463



## Cutting performance

### ● Cutting force comparison

#### 1. Low cutting depth

Material: 1.2379,D2 (raw)  
 Tool dia.:  $\varnothing$  25mm  
 $n=2,548\text{min}^{-1}$ ,  $V_c=200\text{m/min}$ ,  $V_f=1,019\text{mm/min}$ ,  $f=0.4\text{mm/rev}$ ,  
 $a_p=8\text{mm}$ ,  $a_e=7\text{mm}$ , Down cut, Dry

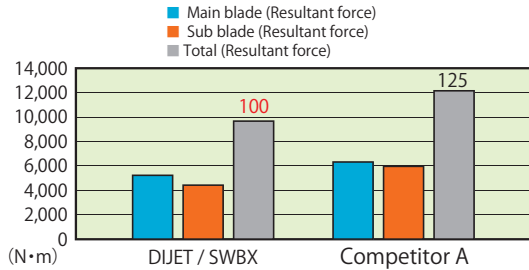

※ SWBX insert: 100

#### 2. High cutting depth

Material: 1.2379,D2 (raw)  
 Tool dia.:  $\varnothing$  25mm  
 $n=2,548\text{min}^{-1}$ ,  $V_c=200\text{m/min}$ ,  $V_f=764\text{mm/min}$ ,  $f=0.3\text{mm/rev}$ ,  
 $a_p=12.5\text{mm}$ ,  $a_e=5\text{mm}$ , Down cut, Dry

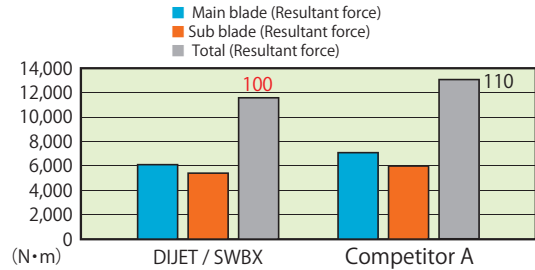

※ SWBX insert: 100

In case of low cutting depth, SWBX type insert reduced 25% cutting force compared with competitor A.  
 In case of high cutting depth reduced 10% cutting force.

### ● Tool life comparison

#### 1. 1.2379,D2 (raw)

Material: 1.2379,D2 (raw)  
 Tool dia.:  $\varnothing$  20mm, Overhung: 50mm  
 Insert: SWBX220HM/HS(JC5240),  
 $n=3,000\text{min}^{-1}$ ,  $V_c=188\text{m/min}$ ,  $V_f=750\text{mm/min}$ ,  $f=0.25\text{mm/rev}$ ,  
 $a_p=5\text{mm}$ ,  $a_e=4\text{mm}$ , Down & up cut, Dry

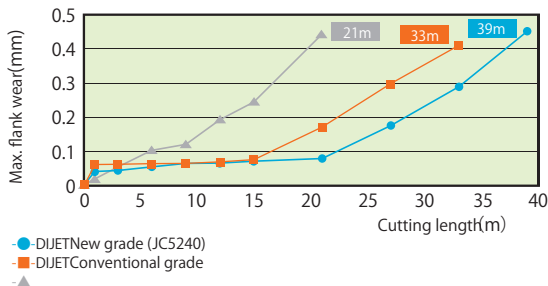

SWBX type insert improved tool life by 1.8 times compared with competitor A, and 1.2 times compared with conventional grade.

#### 2. Stainless steel

Material: Stainless steel  
 Tool dia.:  $\varnothing$  16mm, Overhung: 50mm  
 Insert: SWBX216HM/HS(JC 8 1 1 8)  
 $n=3,980\text{min}^{-1}$ ,  $V_c=200\text{m/min}$ ,  $V_f=2,388\text{mm/min}$ ,  $f=0.6\text{mm/rev}$ ,  
 $a_p=1\text{mm}$ ,  $a_e=1.6\text{mm}$ , Down & up cut, Wet

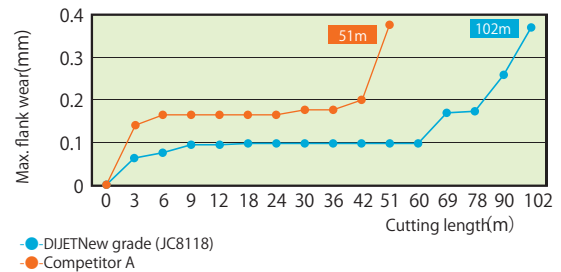

SWBX type insert improved tool life by 2 times compared with competitor A.

#### 3. 1.2379 (welding, 60HRC)

Material: 1.2379,D2 (welding, 60HRC)  
 Tool dia.:  $\varnothing$  25mm  
 Insert: SWBX225MMW/MSW(JC8118)  
 $n=1,898\text{min}^{-1}$ ,  $V_{cmax}=149\text{m/min}$ ,  $V_f=759\text{mm/min}$ ,  $f=0.4\text{mm/rev}$   
 $a_p=0.5\text{mm}$ ,  $a_e=0.7\text{mm}$ , Down & up cut, Dry

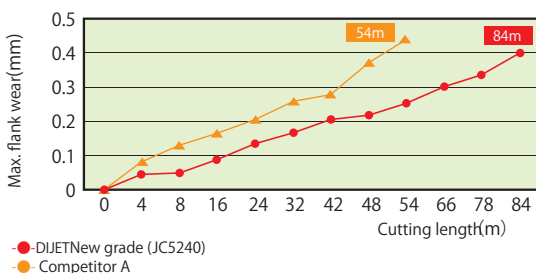

SWBX type insert improved tool life by 1.6 times compared with competitor A.



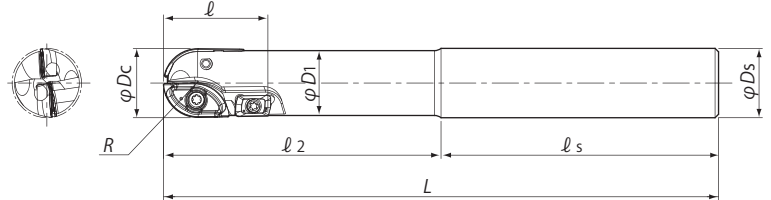

Body (End mill type/Straight shank type)

Cutting conditions 13~16 Page

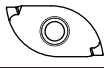
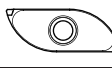

Item code	Stock	No. of inserts			Dimensions (mm)							
		Main blade	Sub blade	Peripheral blade	R	φDc	ℓ	ℓ2	ℓs	L	φD1	φDs
SWBX-16050-S16	●	1	1		8	16	15	50	80	130	15	16
SWBX-20080-S20	●	1	1	1	10	20	29	80	80	160	18.7	20
SWBX-20120-S20	●	1	1	1	10	20	29	120	80	200	18.7	20
SWBX-25080-S25	●	1	1	1	12.5	25	33	80	80	160	23.5	25
SWBX-25120-S25	●	1	1	1	12.5	25	33	120	80	200	23.5	25
SWBX-30120-S32	●	1	1	1	15	30	38	120	80	200	28.8	32
SWBX-30170-S32	●	1	1	1	15	30	38	170	80	250	29	32

Note) 1. All cutters are supplied without inserts.  
 2. All cutters are supplied without wrench & MOLY.  
 3. Please see page 17 for the details of machined form.

Item code	Inserts			Parts			
				Clamp screw		Wrench (not be included)	
	Main blade	Sub blade	Peripheral blade	For main & sub	For peripheral	For main & sub	For peripheral
							
SWBX-16050-S16	SWBX216HM	SWBX216HS		DSW-2563H		A-08SD	
	SWBX216MMW	SWBX216MSW					
SWBX-20080-S20	SWBX220HM	SWBX220HS	ZPMT100308ZER-PL	DSW-307H	TSW-2556H	A-10	A-08
	SWBX220MMW	SWBX220MSW					
SWBX-20120-S20	SWBX220HM	SWBX220HS	ZPMT100308ZER-PL	DSW-307H	TSW-2556H	A-10	A-08
	SWBX220MMW	SWBX220MSW					
SWBX-25080-S25	SWBX225HM	SWBX225HS	ZPMT100308ZER-PL	TSW-410H	TSW-2556H	A-15	A-08
	SWBX225MMW	SWBX225MSW					
SWBX-25120-S25	SWBX225HM	SWBX225HS	ZPMT100308ZER-PL	TSW-410H	TSW-2556H	A-15	A-08
	SWBX225MMW	SWBX225MSW					
SWBX-30120-S32	SWBX230HM	SWBX230HS	ZPMT100308ZER-PL	DSW-511H	DSW-2563H	A-20	A-08SD
	SWBX230MMW	SWBX230MSW					
SWBX-30170-S32	SWBX230HM	SWBX230HS	ZPMT100308ZER-PL	DSW-511H	DSW-2563H	A-20	A-08SD
	SWBX230MMW	SWBX230MSW					

Clamp screw	Recommended torque (N·m)
DSW-2563H	1.1
DSW-307H	2.1
TSW-410H	3.5
DSW-511H	6.1
TSW-2556H	1.1



## Modular head MSWX type

Through coolant hole

Arbor

7~10Page

Cutting conditions

17~18Page

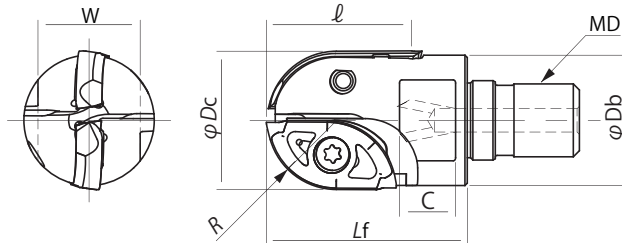

Item code	Stock	No. of inserts		Dimensions(mm)								Inserts		Parts	
		Main blade	Sub blade	R	phi Dc	l	Lf	phi Db	MD	C	W	Main blade	Sub blade	Clamp screw	Wrench (not be included)
MSWX-1615-M8	●	1	1	8	16	15	23	15	M8	8	12	SWBX216HM	SWBX216HS	DSW-2563H	A-08SD
												SWBX216MMW	SWBX216MSW		
MSWX-2022-M10	●	1	1	10	20	22	30	18.7	M10	10	14	SWBX220HM	SWBX220HS	DSW-307H	A-10
												SWBX220MMW	SWBX220MSW		
MSWX-2525-M12	●	1	1	12.5	25	25	35	23.5	M12	11	19	SWBX225HM	SWBX225HS	TSW-410H	A-15
												SWBX225MMW	SWBX225MSW		
MSWX-3031-M16	●	1	1	15	30	31	43	27.9	M16	12	22	SWBX230HM	SWBX230HS	DSW-511H	A-20
												SWBX230MMW	SWBX230MSW		

- Note) 1. All cutters are supplied without inserts.  
 2. All cutters are supplied without wrench & MOLY.  
 3. Please see page 6 for recommended tightening torque.  
 4. Please see page 17 for the details of machined form.

Clamp screw	Recommended torque (N·m)
DSW-2563H	1.1
DSW-307H	2.1
TSW-410H	3.5
DSW-511H	6.1

## Attention

⚠ Attention to mounting head and MSN/ MGN shank holder.

### Tightening procedure

#### ① Cleaning

Remove dirt and chips with air from the connecting thread and face of modular head and MSN/MGN shank holder.

#### ② Initial Tightening

Tighten by hand until the head and the shank holder faces touch.

#### ③ Final Tightening

Tighten slowly with torque control spanner wrench or DIJET DS type spanner wrench and confirm that there is no gap.

Attention : Final tightening without initial tightening cause connecting thread damage.

#### ⚠ Attention

- Note) 1. Use the torque control spanner wrench or DIJET DS type spanner wrench.  
 2. Please gently apply pressure on wrench.  
 3. Please confirm that there is no gap between MSN/MGN shank holder and modular head.

Thread	Tightening Torque	Spanner size W (mm)
M8	16N•m	10, 12 <sup>☆</sup>
M10	16N•m	14, 15
M12	20N•m	17, 19
M16	25N•m	22, 26

- Note) 1. Modular heads are supplied without spanner wrench.  
 2. In case of choosing torque control spanner wrench, confirm that the wrench size is match to the dimensions W & C of each modular head.  
 (There are some cases that modifying the thickness of spanner wrench is necessary)  
 3. ☆ mark shows: DIJET have a stock of DS-8 and 12 type spanner wrenches.

### ⚠ Selection of "MSN Carbide shank holder"

In case of using modular head over  $\phi 16\text{mm}$ , please select MSN carbide shank that diameter ( $\phi D1$ ) is 1mm or more smaller than modular head ( $\phi Dc$ ). A wrong selection causes damage to the carbide shank.

$$\phi Dc - \phi D1 \geq 1\text{mm}$$

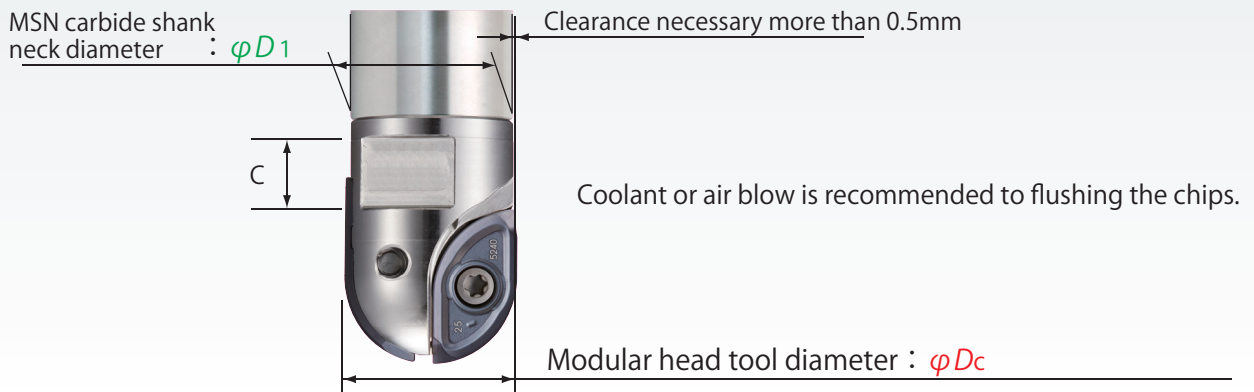

### ⚠ Caution for the mounting to shrink fit holder.

When you use a carbide shank and a modular head on the shrink fit holder, please shrink fit the only carbide shank without mounting a modular head together. Please mount a modular head after shrinking fit operation.

Note) In case of shrink fit MSN shank + modular head together, it will be difficult to loose due to heat desipation.



## MSN Carbide shank holder

Through coolant hole

or high productivity

頑固一徹

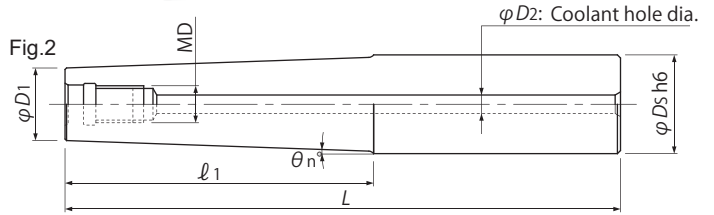
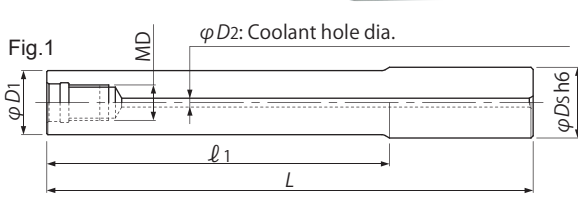

### End mill shank type

Item code	Stock	Dimensions (mm)							Weight (kg)	Fig.
		$\phi D_s$	$\ell_1$	$L$	$\phi D_1$	$\theta_n^\circ$	MD	$\phi D_2$		
MSN-M8-20-S16C	●	16	20	75	15.5	—			0.17	1
MSN-M8-40-S16C	●	16	40	95	15.5	—			0.22	1
MSN-M8-40T-S20C	□	20	40	100	14.5	3°30'			0.36	2
MSN-M8-77T-S20C	●	20	77	143	14.5	1°45'	M8	4	0.49	2
MSN-M8-80-S16C	●	16	80	135	15.5	—			0.32	1
MSN-M8-120-S16C	●	16	120	175	15.5	—			0.42	1
MSN-M8-152-S16C	●	16	152	207	15.5	—			0.51	1
MSN-M10-20-S20C	●	20	20	80	19.5	—			0.29	1
MSN-M10-40-S20C	●	20	40	100	19.5	—			0.39	1
MSN-M10-40T-S20C	●	20	40	100	18.5	0°43'			0.39	2
MSN-M10-70-S20C	●	20	70	130	19.5	—			0.50	1
MSN-M10-85T-S25C	●	25	85	161	18.5	2°			0.90	2
MSN-M10-90-S20C	●	20	90	150	19.5	—	M10	4	0.60	1
MSN-M10-90T-S20C	●	20	90	150	18.5	0°19'			0.58	2
MSN-M10-140-S20C	●	20	140	200	19.5	—			0.80	1
MSN-M10-140T-S20C	●	20	140	200	18.5	0°12'			0.77	2
MSN-M10-160-S20C	●	20	160	220	19.5	—			0.87	1
MSN-M10-210-S20C	●	20	210	270	19.5	—			1.07	1

Note) Please see page 6 for recommended tightening torque.



**MSN**  
TYPE

**MSN Carbide shank holder**

Through coolant hole

For high productivity

頑固一徹

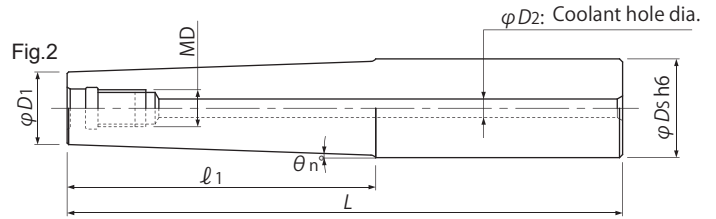
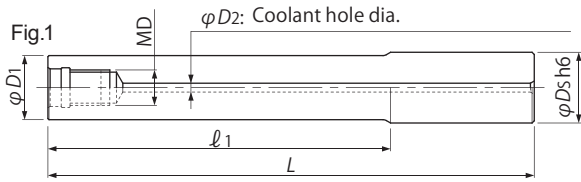

End mill shank type

Item code	Stock	Dimensions (mm)							Weight (kg)	Fig.
		φDs	ℓ1	L	φD1	θn°	MD	φD2		
MSN-M12-25-S25C	●	25	25	90	24	—			0.53	1
MSN-M12-55-S25C	●	25	55	120	24	—			0.72	1
MSN-M12-100T-S32C	□	32	100	180	23.5	2°			1.61	2
MSN-M12-105-S25C	●	25	105	170	24	—	M12	6	1.03	1
MSN-M12-135-S25C	●	25	135	215	24	—			1.30	1
MSN-M12-155-S25C	●	25	155	220	24	—			1.34	1
MSN-M12-200-S25C	●	25	200	265	24	—			1.58	1
MSN-M16-25-S32C	●	32	25	90	29	—			0.85	1
MSN-M16-55-S32C	●	32	55	120	29	—			1.13	1
MSN-M16-77-S32C	●	32	77	157	29	—			1.47	1
MSN-M16-97-S32C	●	32	97	177	29	—			1.64	1
MSN-M16-105-S32C	●	32	105	170	29	—			1.59	1
MSN-M16-117T-S32C	□	32	117	197	29	0°38′			1.88	2
MSN-M16-127-S32C	●	32	127	207	29	—			1.89	1
MSN-M16-127T-S32C	□	32	127	207	29	0°30′			2.23	2
MSN-M16-155-S32C	●	32	155	220	29	—	M16	8	2.04	1
MSN-M16-177-S32C	●	32	177	257	29	—			2.32	1
MSN-M16-177T-S32C	●	32	177	257	29	0°23′			2.78	2
MSN-M16-195-S32C	●	32	195	260	29	—			2.40	1
MSN-M16-197T-S32C	□	32	197	277	29	0°23′			3.00	2
MSN-M16-225-S32C	●	32	225	290	29	—			2.57	1
MSN-M16-245-S32C	●	32	245	310	29	—			2.74	1
MSN-M16-295-S32C	●	32	295	360	29	—			3.17	1

Note) Please see page 6 for recommended tightening torque.



MSN Carbide shank holder

Through coolant hole

For high productivity

頑固一徹

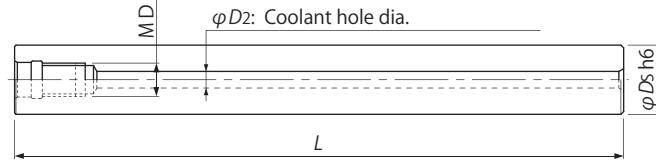

Straight arbor type

Item code	Stock	Dimensions (mm)				Weight (kg)
		$\phi D_s$	L	MD	$\phi D_2$	
MSN-M8-97S-S15C	●	15	97	M8	4	0.21
MSN-M8-147S-S15C	●		147			0.33
MSN-M8-197S-S15C	●		197			0.44
MSN-M8-107S-S16C	●	16	107	M8	4	0.27
MSN-M8-157S-S16C	●		157			0.40
MSN-M10-130S-S18C	●	18	130	M10	4	0.42
MSN-M10-190S-S18C	●		190			0.62
MSN-M10-240S-S18C	●		240			0.89
MSN-M10-130S-S20C	●	20	130	M10	4	0.53
MSN-M10-190S-S20C	●		190			0.78
MSN-M10-250S-S20C	●		250			1.02
MSN-M12-185S-S23C	●	23	185	M12	6	0.98
MSN-M12-265S-S23C	●		265			1.42
MSN-M12-185S-S24C	●	24	185	M12	6	1.07
MSN-M12-265S-S24C	●		265			1.54
MSN-M12-145S-S25C	●	25	145	M12	6	0.91
MSN-M12-215S-S25C	●		215			1.36
MSN-M12-285S-S25C	●		285			1.80
MSN-M16-160S-S28C	●	28	160	M16	8	1.22
MSN-M16-230S-S28C	●		230			1.77
MSN-M16-310S-S28C	●		310			2.41
MSN-M16-157S-S32C	●	32	157	M16	8	1.61
MSN-M16-217S-S32C	●		217			2.22
MSN-M16-287S-S32C	●		287			2.94
MSN-M16-357S-S32C	●		357			3.66

Note) Please see page 6 for recommended tightening torque.



## MGN G-Body steel shank holder

Through coolant hole



- Adopted ultra-rigid and improved body durability "G-Body". ◦ Short type
- Cost-effective and high strength steel shank holder.

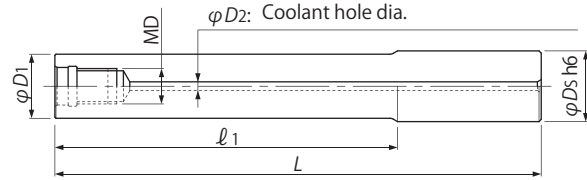
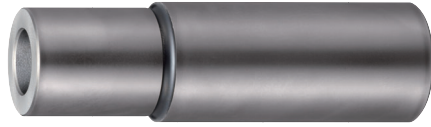

End mill shank type

Item code	Stock	Dimensions (mm)							Weight (kg)
		$\varphi D_s$	$l_1$	$L$	$\varphi D_1$	$\theta_n^\circ$	MD	$\varphi D_2$	
MGN-M8-17-S16	<input type="checkbox"/>	16	17	97	15.5	—	M8	4	0.13
MGN-M10-30-S20	<input type="checkbox"/>	20	30	100	19	—	M10	4	0.21
MGN-M12-35-S25	<input type="checkbox"/>	25	35	105	24	—	M12	4	0.36
MGN-M12-85-S25	<input type="checkbox"/>	25	85	165	24	—	M12	4	0.57
MGN-M16-37-S32	<input type="checkbox"/>	32	37	107	29	—	M16	6	0.56
MGN-M16-77-S32	<input type="checkbox"/>	32	77	157	29	—	M16	6	0.83

Note) 1. In case of using modular head combined with MGN steel shank holder, apply the recommended cutting conditions sheet (see page 17–18).  
2. Please see page 6 for recommended tightening torque.



Adopted GN surface-hardening treatment on thermal resistant high strength steel gives high hardness over 65HRC and secure insert pocket and holder against thermal deformation, improved body durability and tool life by 30% or more, compared with competitor's tool. Make it difficult to be damaged even under severe cutting conditions. Also rust-proof and anti-welding effect is much improved.

## Inserts

Fig.1 (Main blade for low cutting force)

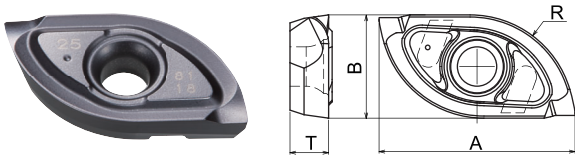

Fig.3 (Sub blade for low cutting force)

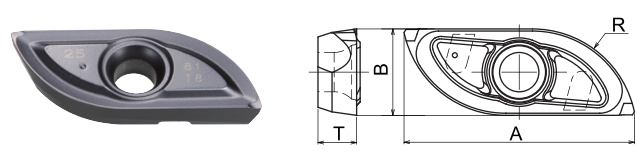

Fig.2(Main blade for welding & hardened material)

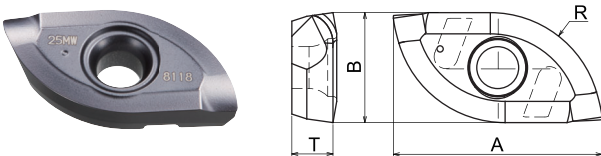

Fig.4 (Sub blade for welding & hardened material)

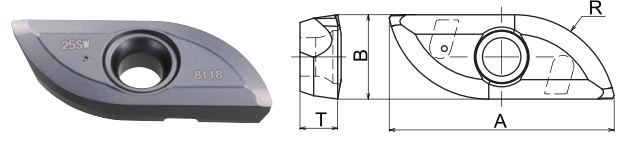
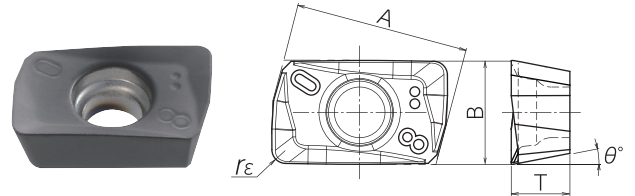

Fig.5 (Peripheral blade)



Item code	Type	PVD coated			Dimensions (mm)					Fig.
		JC5240	JC8118	JC8015	R	A	B	T	r	
SWBX216HM	Main (for low cutting force)	●	●		8	15	7.9	3.3	—	1
SWBX216MMW	Main (for welding & hardened material)		●		8	15	7.9	3.3	—	2
SWBX216HS	Sub (for low cutting force)	●	●		8	16.1	6.6	3.3	—	3
SWBX216MSW	Sub (for welding & hardened material)		●		8	16.1	6.6	3.3	—	4
SWBX220HM	Main (for low cutting force)	●	●		10	18.8	9.9	3.9	—	1
SWBX220MMW	Main (for welding & hardened material)		●		10	18.8	9.9	3.9	—	2
SWBX220HS	Sub (for low cutting force)	●	●		10	22.9	8.8	3.9	—	3
SWBX220MSW	Sub (for welding & hardened material)		●		10	22.9	8.8	3.9	—	4
SWBX225HM	Main (for low cutting force)	●	●		12.5	22.3	12.4	4.6	—	1
SWBX225MMW	Main (for welding & hardened material)		●		12.5	22.3	12.4	4.6	—	2
SWBX225HS	Sub (for low cutting force)	●	●		12.5	26.3	10.5	4.6	—	3
SWBX225MSW	Sub (for welding & hardened material)		●		12.5	26.3	10.5	4.6	—	4
SWBX230HM	Main (for low cutting force)	●	●		15	27.9	14.7	6	—	1
SWBX230MMW	Main (for welding & hardened material)			●	15	27.9	14.7	6	—	2
SWBX230HS	Sub (for low cutting force)	●	●		15	32.8	12.3	6	—	3
SWBX230MSW	Sub (for welding & hardened material)			●	15	32.8	12.3	6	—	4
ZPMT100308ZER-PL	Peripheral		●		—	10	6	3.4	0.8	5

10 inserts per case.

Note) 1. Please see page 13-18 for cutting conditions and page 17 for the details of machined form.  
2. Be sure to use the same type & the same grade for main & sub blade together.



## Cutting data

### 1. Machining turbine blade

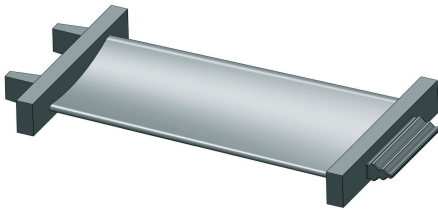
 <p>Overhung length: 50mm</p>	Work	Part name	Turbine blade
		Material	Stainless steel (1.4034)
Hardness		–	
<p>Result</p> <p>Compared with competitor's, MSWX reduced machining time by half and improved tool life by 3 times (machined 300 works). No chatter and good surface roughness.</p>	Tool	Tool No.	MSWX-1615-M8 MSN-M8-40-S16C
		Insert No.	SWBX216HM/HS (JC8118)
	Cutting conditions	n, Vc	n=2,300min <sup>-1</sup> (Vc=115m/min)
		Vf, f	Vf=1,051mm/min (f=0.46mm/rev)
		a <sub>p</sub> (mm)	1mm
		a <sub>e</sub> (mm)	1mm
		Coolant	Water soluble
Machine	Vertical MC		

### 2. Machining stamping die

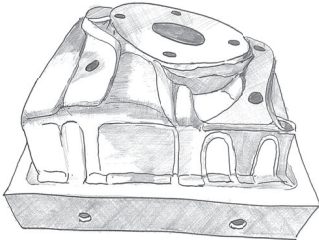
 <p>Overhung length: 65mm</p>	Work	Part name	Stamping die
		Material	1.2379, D2
Hardness		59HRC	
<p>Result</p> <p>After 17.5 hours (cutting length: 2km), inserts showed normal wear and were still able to continue.</p>	Tool	Tool No.	MSWX-2022-M10 MSN-M10-40-S20C
		Insert No.	SWBX220MMW/MSW (JC8118)
	Cutting conditions	n, Vc	n=2,500min <sup>-1</sup> (Vc=157m/min)
		Vf, f	Vf=1,500mm/min (f=0.6mm/rev)
		a <sub>p</sub> (mm)	0.4mm
		a <sub>e</sub> (mm)	0.4mm
		Coolant	Mist coolant
Machine	Vertical MC (HSK63)		

### 3. Machining forging die

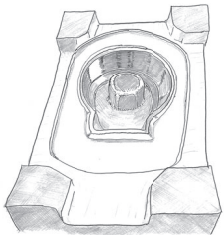
 <p>Overhung length: 80mm</p>	Work	Part name	Forging die
		Material	SKT4 1.2713
Hardness		42HRC	
<p>Result</p> <p>Total machining time of roughing &amp; finishing is 20 hours. No chatter and good surface roughness.</p>	Tool	Tool No.	SWBX-25080-S25
		Insert No.	SWBX225MMW/MSW (JC8118)
	Cutting conditions	n, Vc	n=1,850min <sup>-1</sup> (Vc=145m/min)
		Vf, f	Vf=900mm/min (f=0.49mm/rev)
		a <sub>p</sub> (mm)	Roughing: 2mm, finishing: 1mm
		a <sub>e</sub> (mm)	Roughing: 4mm, finishing: 1mm
		Coolant	Air blow
Machine	Vertical MC		

### 4. Machining welding part

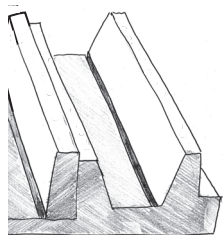
 <p>Overhung length: 120mm</p>	Work	Part name	Stamping die
		Material	1.2379+welding
Hardness		60HRC+55HRC	
<p>Result</p> <p>Machined welding part for 1 hour. Inserts were still good conditions (no breakage and normal wear).</p>	Tool	Tool No.	SWBX-30120-S32
		Insert No.	SWBX230MMW/MSW (JC8015)
	Cutting conditions	n, Vc	n=3,000min <sup>-1</sup> (Vc=283m/min)
		Vf, f	Vf=1,800mm/min (f=0.6mm/rev)
		a <sub>p</sub> (mm)	1mm
		a <sub>e</sub> (mm)	1mm
		Coolant	Air blow
Machine	Vertical MC		

### Recommended cutting conditions for Swing Ball-NEO 16mm dia.

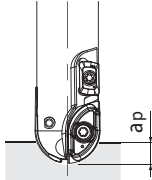
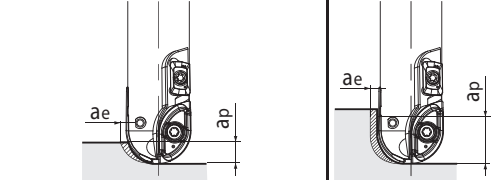
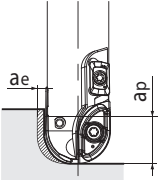
Type of machining				Slotting	Shoulder cutting		Shoulder cutting
Materials	Insert type	Grade	Parameter				
				ap	ae	ap	ae
Carbon steel (C50,C55) Below 250HB	HM/HS	JC5240 (JC8118)	n (min <sup>-1</sup> )	4,000	4,000	4,000	3,400
			Vf (mm/min)	560	1,000	800	680
			ap(mm)	4	4	8	12
			ae(mm)	—	3	4	1
Cast steel (1.7225) Below 285HB	HM/HS	JC5240 (JC8118)	n (min <sup>-1</sup> )	3,800	3,800	3,800	3,400
			Vf (mm/min)	530	950	760	680
			ap(mm)	4	4	8	12
			ae(mm)	—	3	4	1
Die steel, (1.2344,1.2379) Below 255HB	HM/HS	JC5240 (JC8118)	n (min <sup>-1</sup> )	3,400	3,400	3,400	2,900
			Vf (mm/min)	680	740	680	640
			ap(mm)	4	4	8	12
			ae(mm)	—	3	4	1
Mold steel (1.2311,P20) 30-36HRC	HM/HS	JC8118	n (min <sup>-1</sup> )	3,400	3,400	3,400	3,200
			Vf (mm/min)	680	740	680	640
			ap(mm)	4	4	8	12
			ae(mm)	—	3	4	1
Mold steel (1.2311,P21) 38-43HRC	HM/HS	JC8118	n (min <sup>-1</sup> )	3,000	3,000	3,000	2,800
			Vf (mm/min)	430	600	600	640
			ap(mm)	4	4	8	12
			ae(mm)	—	3	4	1
Hardened die steel (1.2344,1.2379) 42-52HRC	MMW/MSW (HM/HS)	JC8118	n (min <sup>-1</sup> )	2,200	2,200	2,200	—
			Vf (mm/min)	260	440	330	—
			ap(mm)	2	2	6	—
			ae(mm)	—	2	1	—
Hardened die steel (1.2379) 55-62HRC	MMW/MSW	JC8118	n (min <sup>-1</sup> )	1,200	1,700	—	—
			Vf (mm/min)	150	400	—	—
			ap(mm)	1	~1	—	—
			ae(mm)	—	2	—	—
Grey iron (GG25) 160-260HB	HM/HS (MMW/MSW)	JC8118	n (min <sup>-1</sup> )	3,800	3,800	3,800	2,800
			Vf (mm/min)	950	1,400	1,300	700
			ap(mm)	4	4	8	12
			ae(mm)	—	5	4	1
Nodular cast iron (GGG70) 170-300HB	HM/HS	JC5240 (JC8118)	n (min <sup>-1</sup> )	3,800	3,800	3,800	3,400
			Vf (mm/min)	530	950	760	680
			ap(mm)	4	4	8	12
			ae(mm)	—	3	4	1
Stainless steel Austenitic (AISI 304, 316, 317)	HM/HS	JC8118	n (min <sup>-1</sup> )	3,400	3,400	3,400	3,200
			Vf (mm/min)	680	740	680	640
			ap(mm)	4	4	8	12
			ae(mm)	—	3	4	1
Stainless steel Ferritics/Martensitic (AISI 403, 420J2, 430)	HM/HS	JC8118	n (min <sup>-1</sup> )	4,000	4,000	4,000	3,400
			Vf (mm/min)	560	1,000	800	680
			ap(mm)	4	4	8	12
			ae(mm)	—	3	4	1

#### NOTE

- 1) The figure to be adjusted according to the machine rigidity or work rigidity.
- 2) In case of chatter occurring, recommend to reduce the depth of cut ap or Spindle speed and keep feed per tooth.

Recommended cutting conditions for Swing Ball-NEO 20mm dia.

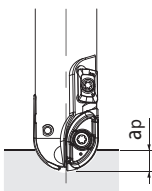
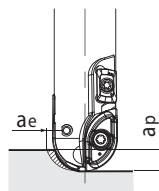
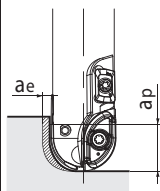
Type of machining				Slotting	Shoulder cutting		Shoulder cutting
Materials	Insert type	Grade	Parameter				
Carbon steel (C50,C55) Below 250HB	HM/HS	JC5240 (JC8118)	n (min <sup>-1</sup> )	3,180	3,180	3,180	2,680
			Vf (mm/min)	890	1,000	800	570
			ap(mm)	5	5	10	16
			ae(mm)	—	4	5	2
Cast steel (1.7225) Below 285HB	HM/HS	JC5240 (JC8118)	n (min <sup>-1</sup> )	3,020	3,020	3,020	2,700
			Vf (mm/min)	820	920	760	540
			ap(mm)	5	5	10	16
			ae(mm)	—	4	5	2
Die steel, (1.2344,1.2379) Below 255HB	HM/HS	JC5240 (JC8118)	n (min <sup>-1</sup> )	2,700	2,700	2,700	2,390
			Vf (mm/min)	680	810	630	480
			ap(mm)	5	5	10	16
			ae(mm)	—	4	5	2
Mold steel (1.2311,P20) 30-36HRC	HM/HS	JC8118	n (min <sup>-1</sup> )	3,020	3,020	3,020	2,700
			Vf (mm/min)	450	650	600	540
			ap(mm)	5	5	10	16
			ae(mm)	—	4	5	2
Mold steel (1.2311,P21) 38-43HRC	HM/HS	JC8118	n (min <sup>-1</sup> )	2,700	2,700	2,700	2,400
			Vf (mm/min)	400	580	530	480
			ap(mm)	5	5	10	16
			ae(mm)	—	4	5	2
Hardened die steel (1.2344,1.2379) 42-52HRC	MMW/MSW (HM/HS)	JC8118	n (min <sup>-1</sup> )	1,750	1,750	1,750	—
			Vf (mm/min)	350	400	320	—
			ap(mm)	~2	~2	~4	—
			ae(mm)	—	3	4	—
Hardened die steel (1.2379) 55-62HRC	MMW/MSW	JC8118	n (min <sup>-1</sup> )	1,400	1,400	—	—
			Vf (mm/min)	280	350	—	—
			ap(mm)	~1	~1	—	—
			ae(mm)	—	3	—	—
Grey iron (GG25) 160-260HB	HM/HS (MMW/MSW)	JC8118	n (min <sup>-1</sup> )	3,180	3,180	3,180	2,860
			Vf (mm/min)	1,160	1,300	1,040	740
			ap(mm)	5	5	10	16
			ae(mm)	—	4	5	2
Nodular cast iron (GGG70) 170-300HB	HM/HS	JC5240 (JC8118)	n (min <sup>-1</sup> )	3,020	3,020	3,020	2,700
			Vf (mm/min)	820	920	760	540
			ap(mm)	5	5	10	16
			ae(mm)	—	4	5	2
Stainless steel Austenitic (AISI 304, 316, 317)	HM/HS	JC8118	n (min <sup>-1</sup> )	3,020	3,020	3,020	2,700
			Vf (mm/min)	450	650	600	540
			ap(mm)	5	5	10	16
			ae(mm)	—	4	5	2
Stainless steel Ferritics/Martensitic (AISI 403, 420J2, 430)	HM/HS	JC8118	n (min <sup>-1</sup> )	3,180	3,180	3,180	2,680
			Vf (mm/min)	890	1,000	800	570
			ap(mm)	5	5	10	16
			ae(mm)	—	4	5	2

NOTE

- 1) The figure to be adjusted according to the machine rigidity or work rigidity.
- 2) In case of chatter occurring, recommend to reduce the depth of cut ap or Spindle speed and keep feed per tooth.

### Recommended cutting conditions for Swing Ball-NEO 25mm dia.

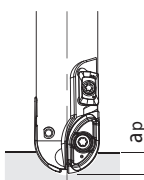
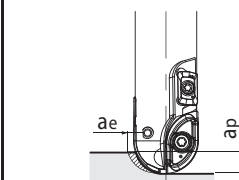
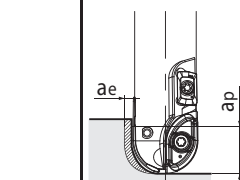
Type of machining				Slotting	Shoulder cutting		Shoulder cutting
Materials	Insert type	Grade	Parameter				
Carbon steel (C50,C55) Below 250HB	HM/HS	JC5240 (JC8118)	n (min <sup>-1</sup> )	2,550	2,550	2,550	2,290
			Vf (mm/min)	760	890	690	500
			ap(mm)	6	6	12.5	20
			ae(mm)	—	5	6.5	3
Cast steel (1.7225) Below 285HB	HM/HS	JC5240 (JC8118)	n (min <sup>-1</sup> )	2,400	2,400	2,400	2,160
			Vf (mm/min)	720	840	640	480
			ap(mm)	6	6	12.5	20
			ae(mm)	—	5	6.5	3
Die steel, (1.2344,1.2379) Below 255HB	HM/HS	JC5240 (JC8118)	n (min <sup>-1</sup> )	2,160	2,160	2,160	1,910
			Vf (mm/min)	590	690	540	420
			ap(mm)	6	6	12.5	20
			ae(mm)	—	5	6.5	3
Mold steel (1.2311,P20) 30-36HRC	HM/HS	JC8118	n (min <sup>-1</sup> )	2,400	2,400	2,400	2,160
			Vf (mm/min)	480	530	480	430
			ap(mm)	6	6	12.5	20
			ae(mm)	—	5	6.5	3
Mold steel (1.2311,P21) 38-43HRC	HM/HS	JC8118	n (min <sup>-1</sup> )	2,100	2,100	2,100	1,900
			Vf (mm/min)	420	460	420	380
			ap(mm)	6	6	12.5	20
			ae(mm)	—	5	6.5	3
Hardened die steel (1.2344,1.2379) 42-52HRC	MMW/MSW (HM/HS)	JC8118	n (min <sup>-1</sup> )	1,600	1,600	1,600	—
			Vf (mm/min)	350	400	350	—
			ap(mm)	~3	~3	~5	—
			ae(mm)	—	4	5	—
Hardened die steel (1.2379) 55-62HRC	MMW/MSW	JC8118	n (min <sup>-1</sup> )	1,400	1,400	—	—
			Vf (mm/min)	280	350	—	—
			ap(mm)	~2	~2	—	—
			ae(mm)	—	4	—	—
Grey iron (GG25) 160-260HB	HM/HS (MMW/MSW)	JC8118	n (min <sup>-1</sup> )	2,550	2,550	2,550	2,290
			Vf (mm/min)	1,000	1,150	900	650
			ap(mm)	6	6	12.5	20
			ae(mm)	—	5	6.5	3
Nodular cast iron (GGG70) 170-300HB	HM/HS	JC5240 (JC8118)	n (min <sup>-1</sup> )	2,400	2,400	2,400	2,160
			Vf (mm/min)	720	840	640	480
			ap(mm)	6	6	12.5	20
			ae(mm)	—	5	6.5	3
Stainless steel Austenitic (AISI 304, 316, 317)	HM/HS	JC8118	n (min <sup>-1</sup> )	2,400	2,400	2,400	2,160
			Vf (mm/min)	480	530	480	430
			ap(mm)	6	6	12.5	20
			ae(mm)	—	5	6.5	3
Stainless steel Ferritics/Martensitic (AISI 403, 420J2, 430)	HM/HS	JC8118	n (min <sup>-1</sup> )	2,550	2,550	2,550	2,290
			Vf (mm/min)	760	890	690	500
			ap(mm)	6	6	12.5	20
			ae(mm)	—	5	6.5	3

NOTE

- 1) The figure to be adjusted according to the machine rigidity or work rigidity.
- 2) In case of chatter occurring, recommend to reduce the depth of cut ap or Spindle speed and keep feed per tooth.

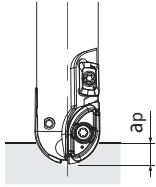
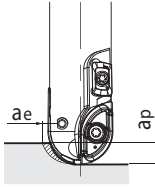
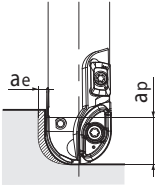

Recommended cutting conditions for Swing Ball-NEO 30mm dia.

Type of machining				Slotting	Shoulder cutting		Shoulder cutting
Materials	Insert type	Grade	Parameter				
				ap	ae	ap	ae
Carbon steel (C50,C55) Below 250HB	HM/HS	JC5240 (JC8118)	n (min <sup>-1</sup> )	2,300	2,300	2,300	1,800
			Vf (mm/min)	800	1,020	770	450
			ap(mm)	10	10	16	28
			ae(mm)	—	6	9	6
Cast steel (1.7225) Below 285HB	HM/HS	JC5240 (JC8118)	n (min <sup>-1</sup> )	2,090	2,090	2,090	1,670
			Vf (mm/min)	720	920	700	420
			ap(mm)	10	10	16	28
			ae(mm)	—	6	9	6
Die steel, (1.2344,1.2379) Below 255HB	HM/HS	JC5240 (JC8118)	n (min <sup>-1</sup> )	1,950	1,950	1,950	1,560
			Vf (mm/min)	630	810	600	390
			ap(mm)	10	10	16	28
			ae(mm)	—	6	9	3
Mold steel (1.2311,P20) 30-36HRC	HM/HS	JC8118	n (min <sup>-1</sup> )	2,060	2,060	2,060	1,650
			Vf (mm/min)	310	600	400	330
			ap(mm)	10	10	16	28
			ae(mm)	—	6	9	6
Mold steel (1.2311,P21) 38-43HRC	HM/HS	JC8118	n (min <sup>-1</sup> )	1,800	1,800	1,800	1,500
			Vf (mm/min)	270	540	350	290
			ap(mm)	10	10	16	28
			ae(mm)	—	6	9	6
Hardened die steel (1.2344,1.2379) 42-52HRC	MMW/MSW (HM/HS)	JC8015 (JC8118)	n (min <sup>-1</sup> )	1,600	1,600	1,600	—
			Vf (mm/min)	400	480	400	—
			ap(mm)	~ 4	~4	~6.5	—
			ae(mm)	—	5	8	—
Hardened die steel (1.2379) 55-62HRC	MMW/MSW	JC8015	n (min <sup>-1</sup> )	1,400	1,400	—	—
			Vf (mm/min)	280	350	—	—
			ap(mm)	~ 3	~ 3	—	—
			ae(mm)	—	5	—	—
Grey iron (GG25) 160-260HB	HM/HS (MMW/MSW)	JC8118 (JC8015)	n (min <sup>-1</sup> )	2,300	2,300	2,300	1,840
			Vf (mm/min)	1,140	1,380	1,020	640
			ap(mm)	10	10	16	28
			ae(mm)	—	6	9	6
Nodular cast iron (GGG70) 170-300HB	HM/HS	JC5240 (JC8118)	n (min <sup>-1</sup> )	2,090	2,090	2,090	1,670
			Vf (mm/min)	720	920	700	420
			ap(mm)	10	10	16	28
			ae(mm)	—	6	9	6
Stainless steel Austenitic (AISI 304, 316, 317)	HM/HS	JC8118	n (min <sup>-1</sup> )	2,060	2,060	2,060	1,650
			Vf (mm/min)	310	600	400	330
			ap(mm)	10	10	16	28
			ae(mm)	—	6	9	6
Stainless steel Ferritics/Martensitic (AISI 403, 420J2, 430)	HM/HS	JC8118	n (min <sup>-1</sup> )	2,300	2,300	2,300	1,800
			Vf (mm/min)	800	1,020	770	450
			ap(mm)	10	10	16	28
			ae(mm)	—	6	9	6

NOTE

- 1) The figure to be adjusted according to the machine rigidity or work rigidity.
- 2) In case of chatter occurring, recommend to reduce the depth of cut ap or Spindle speed and keep feed per tooth.

### Recommended cutting conditions for MSWX and MSN

Materials	Insert type	Grade	Tool dia. (mm)														
			16					20					25				
			$\ell$ (mm)	$a_p$ (mm)	$a_e$ (mm)	$n$ (min <sup>-1</sup> )	$V_f$ (mm/min)	$\ell$ (mm)	$a_p$ (mm)	$a_e$ (mm)	$n$ (min <sup>-1</sup> )	$V_f$ (mm/min)	$\ell$ (mm)	$a_p$ (mm)	$a_e$ (mm)	$n$ (min <sup>-1</sup> )	$V_f$ (mm/min)
Carbon steel (C50,C55) Below 250HB	HM/HS	JC5240 (JC8118)	50	1.1	1.0	4,200	2,900	70	1.3	1.3	4,800	3,360	90	1.3	1.3	3,800	2,700
			100	0.7	0.7	4,200	2,900	120	0.8	0.8	4,800	3,360	140	0.8	0.8	3,800	2,700
			150	0.3	0.3	3,600	2,520	190	0.3	0.4	4,000	2,800	210	0.3	0.5	3,200	2,200
Cast steel (1.7225) Below 285HB	HM/HS	JC8118 (JC5240)	50	1.1	1.0	4,000	2,800	70	1.3	1.3	4,000	2,800	90	1.3	1.3	3,200	2,240
			100	0.7	0.7	4,000	2,800	120	0.8	0.8	4,000	2,800	140	0.8	0.8	3,200	2,240
			150	0.3	0.3	3,400	2,380	190	0.3	0.4	3,600	2,500	210	0.3	0.5	2,800	1,960
Die steel, (1.2344,1.2379) Below 255HB	HM/HS	JC5240 (JC8118)	50	1.1	1.0	4,000	2,800	70	1.3	1.3	4,000	2,800	90	1.3	1.3	3,200	2,240
			100	0.7	0.7	4,000	2,800	120	0.8	0.8	4,000	2,800	140	0.8	0.8	3,200	2,240
			150	0.3	0.3	3,400	2,400	190	0.3	0.4	3,600	2,500	210	0.3	0.5	2,800	1,960
Mold steel (1.2311,P20) 30-36HRC	HM/HS	JC8118	50	1.1	1.0	3,600	2,100	70	1.3	1.3	2,800	1,700	90	1.3	1.3	2,300	1,400
			100	0.7	0.7	3,600	2,100	120	0.8	0.8	2,800	1,700	140	0.8	0.8	2,300	1,400
			150	0.3	0.3	3,000	1,800	190	0.3	0.4	2,400	1,400	210	0.3	0.5	2,000	1,200
Mold steel (1.2311,P21) 38-43HRC	HM/HS	JC8118	50	1.1	1.0	3,600	2,100	70	1.3	1.3	2,800	1,700	90	1.3	1.3	2,300	1,400
			100	0.7	0.7	3,600	2,100	120	0.8	0.8	2,800	1,700	140	0.8	0.8	2,300	1,400
			150	0.3	0.3	3,000	1,800	190	0.3	0.4	2,400	1,400	210	0.3	0.5	2,000	1,200
Hardened die steel (1.2344,1.2379) 42-52HRC	HW/HS (MMW/MSW)	JC8118	50	0.8	0.8	3,000	1,800	70	0.8	0.9	2,400	1,200	90	1.0	1.0	1,900	1,140
			100	0.6	0.6	2,800	1,400	120	0.6	0.7	2,200	1,100	140	0.8	0.8	1,800	900
			150	0.2	0.2	2,300	920	190	0.2	0.3	1,900	760	210	0.3	0.5	1,500	600
Hardened die steel (1.2379) 55-62HRC	MMW/MSW	JC8118	50	0.5	0.5	2,400	1,200	70	0.5	0.5	1,900	950	90	0.5	0.7	1,500	750
			100	0.3	0.3	2,200	880	120	0.3	0.4	1,800	800	140	0.3	0.5	1,400	560
			150	0.1	0.2	2,000	800	190	0.1	0.2	1,600	640	210	0.1	0.3	1,300	520
Grey iron (GG25) 160-260HB	HM/HS (MMW/MSW)	JC8118	50	1.3	1.3	4,000	2,800	70	1.5	1.5	3,200	2,200	90	1.5	1.5	2,600	1,800
			100	1.0	1.0	4,000	2,800	120	1.0	1.0	3,200	2,200	140	1.0	1.0	2,600	1,800
			150	0.5	0.4	3,400	2,400	190	0.5	0.4	2,700	1,900	210	0.5	0.5	1,900	1,300
Nodular cast iron (GGG70) 170-300HB	HM/HS	JC8118 (JC5240)	50	1.1	1.0	4,000	2,800	70	1.3	1.3	4,000	2,800	90	1.3	1.3	3,200	2,240
			100	0.7	0.7	4,000	2,800	120	0.8	0.8	4,000	2,800	140	0.8	0.8	3,200	2,240
			150	0.3	0.3	3,400	2,380	190	0.3	0.4	3,600	2,500	210	0.3	0.5	2,800	1,960
Stainless steel Austenitic (AISI 304, 316, 317)	HM/HS	JC8118	50	1.1	1.0	3,600	2,100	70	1.3	1.3	2,800	1,700	90	1.3	1.3	2,300	1,400
			100	0.7	0.7	3,600	2,100	120	0.8	0.8	2,800	1,700	140	0.8	0.8	2,300	1,400
			150	0.3	0.3	3,000	1,800	190	0.3	0.4	2,400	1,400	210	0.3	0.5	2,000	1,200
Stainless steel Ferritic/Martensitic (AISI 403, 420J2, 430)	HM/HS	JC8118	50	1.1	1.0	4,200	2,900	70	1.3	1.3	4,800	3,360	90	1.3	1.3	3,800	2,700
			100	0.7	0.7	4,200	2,900	120	0.8	0.8	4,800	3,360	140	0.8	0.8	3,800	2,700
			150	0.3	0.3	3,600	2,520	190	0.3	0.4	4,000	2,800	210	0.3	0.5	3,200	2,200

NOTE) 1.The figure to be adjusted according to the machine rigidity or work rigidity.  
2.Use air blow.

### Machined form by Swing Ball-NEO

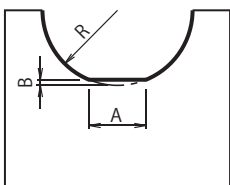

● SWBX Type

R	A	B
8	0.5	0.01
10	1.2	0.02
12.5	1.4	0.02
15	1.7	0.03

Note) At center point as shown in above figure, material can be left as mentioned in chart.

Materials	Insert type	Grade	Tool dia. (mm)								
			30								
			$l$ (mm)	$a_p$ (mm)	$a_e$ (mm)	$n$ (min <sup>-1</sup> )	$V_f$ (mm/min)				
Carbon steel (C50,C55) Below 250HB	HM/HS	JC5240 (JC8118)	100	1.5	1.5	3,000	2,100				
			150	1.0	1.0	3,000	2,100				
			210	0.3	0.7	2,650	1,860				
Cast steel (1.7225) Below 285HB	HM/HS	JC8118 (JC5240)	100	1.5	1.5	2,600	1,820				
			150	1.0	1.0	2,600	1,820				
			210	0.3	0.7	2,300	1,600				
Die steel, (1.2344,1.2379) Below 255HB	HM/HS	JC5240 (JC8118)	100	1.5	1.5	2,600	1,820				
			150	1.0	1.0	2,600	1,820				
			210	0.3	0.7	2,300	1,600				
Mold steel (1.2311,P20) 30-36HRC	HM/HS	JC8118	100	1.5	1.5	1,900	1,100				
			150	1.0	1.0	1,900	1,100				
			210	0.3	0.7	1,600	1,000				
Mold steel (1.2311,P21) 38-43HRC	HM/HS	JC8118	100	1.5	1.5	1,900	1,100				
			150	1.0	1.0	1,900	1,100				
			210	0.3	0.7	1,600	1,000				
Hardened die steel (1.2344,1.2379) 42-52HRC	HM/HS (MMW/MSW)	JC8118 (JC8015)	100	1.0	1.2	1,600	960				
			150	0.8	1.0	1,500	750				
			210	0.3	0.8	1,300	520				
Hardened die steel (1.2379) 55-62HRC	MMW/MSW	JC8015	100	0.6	0.8	1,300	650				
			150	0.3	0.7	1,200	480				
			210	0.1	0.5	1,100	440				
Grey iron (GG25) 160-260HB	HM/HS (MMW/MSW)	JC8118 (JC8015)	100	1.5	1.5	2,200	1,500				
			150	1.0	1.0	2,200	1,500				
			210	0.5	0.7	1,800	1,200				
Nodular cast iron (GGG70) 170-300HB	HM/HS	JC8118 (JC5240)	100	1.5	1.5	2,600	1,820				
			150	1.0	1.0	2,600	1,820				
			210	0.3	0.7	2,300	1,600				
Stainless steel Austenitic (AISI 304, 316, 317)	HM/HS	JC8118	100	1.5	1.5	1,900	1,100				
			150	1.0	1.0	1,900	1,100				
			210	0.3	0.7	1,600	1,000				
Stainless steel Ferritics/Martensitic (AISI 403, 420J2, 430)	HM/HS	JC8118	100	1.5	1.5	3,000	2,100				
			150	1.0	1.0	3,000	2,100				
			210	0.3	0.7	2,650	1,860				

NOTE) 1.The figure to be adjusted according to the machine rigidity or work rigidity.  
2.Use air blow.

### Maximum plunging depth and feed rate for Swing Ball-NEO

Materials	Max.value	Tool dia.: $\varphi D_c$ (mm)			
		16	20	25	30
Cast iron (GG,GGG)	$a_p$ (mm)	3	4	5	10
	$f$ (mm/rev)	0.25	0.30	0.40	0.40
Cast steel, Alloy steel, Die steel	$a_p$ (mm)	2	3	4	8
	$f$ (mm/rev)	0.2	0.25	0.30	0.30

$a_p$  : Depth of cut,  $f$  : feed



## HEADQUARTER

**DIJET Industrial Co.Ltd.**

2-1-18, Kami-Higashi,

Hirano-ku, Osaka 547-0002, Japan

PHONE +81-6-6791-6781

FAX +81-6-6793-1221

## MAIN OFFICE EUROPE

**DIJET GmbH**

Immermannstraße 9

40210 Düsseldorf, Germany

PHONE +49-211-50088820

FAX +49-211-50088823



DIJET EUROPE

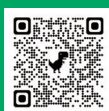

DIJET GmbH

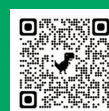

Web : [www.dijet.de](http://www.dijet.de)

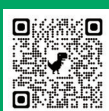

Please register to DIJET-Club  
[dijet-club.com](http://dijet-club.com) →

